

ShenZhen Suntech Company Limited

Product Specification

Product name: UCS2903 120LEDs Addressable RGB LED Strip

1. Product Picture:

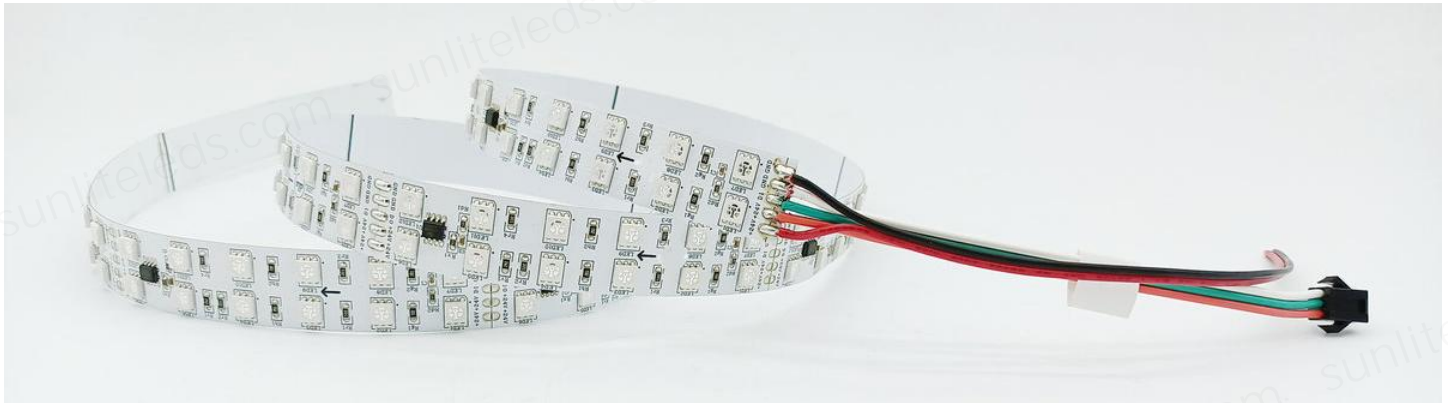

2. Product Description

(1) Personalized customization: Print your logo on the PCB, and do customized packages are acceptable.

(2) Multi-selectivity: The color and width of PCB board could be selected. PCB thickness can be 2oz, 3oz. From IP20 to IP68 styles are all available, Suit for both indoor lighting and outdoor projects.

(3) Easy installation: Self-adhesive 3M tape on back, it can be fixed on any dry and flat surface without any screws and clips.

(4) Widely Application: It is widely used in wall corridor, indoor environment decoration, entertainment places, wine cabinet bar backlight, ceiling backlight, LED light box light source, LED luminous brand, aquarium supplies, car decoration and so on.

(5) High quality: Long lifespan 50000 hours, 3 years warranty and 5 years warranty for options.

3.Product Dimension :

UCS2903 DC24V RGB 20mm width:

Dimension (unit:mm/in)

DC24V

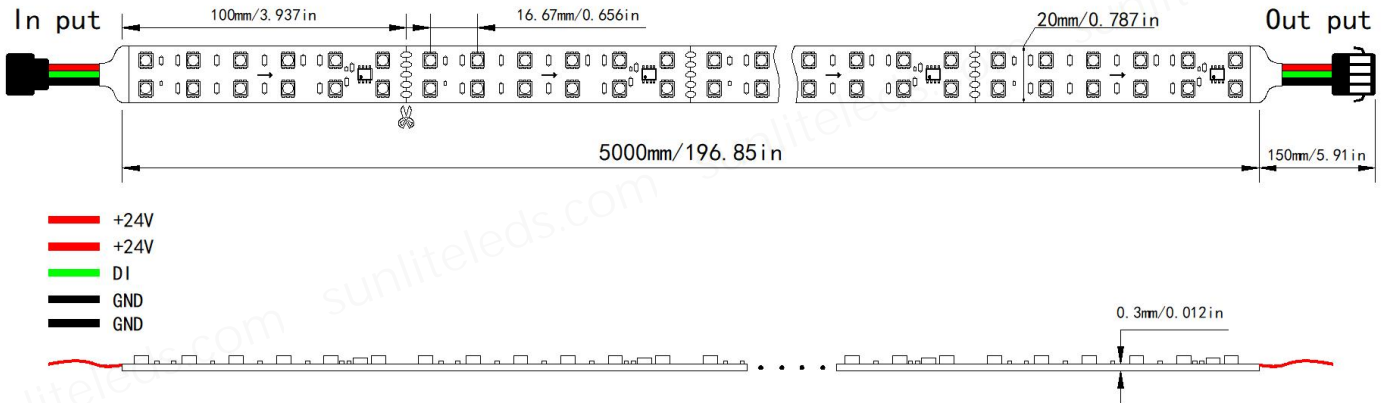

UCS2903 DC24V RGB 15mm width:

Dimension (unit:mm/in)

DC24V

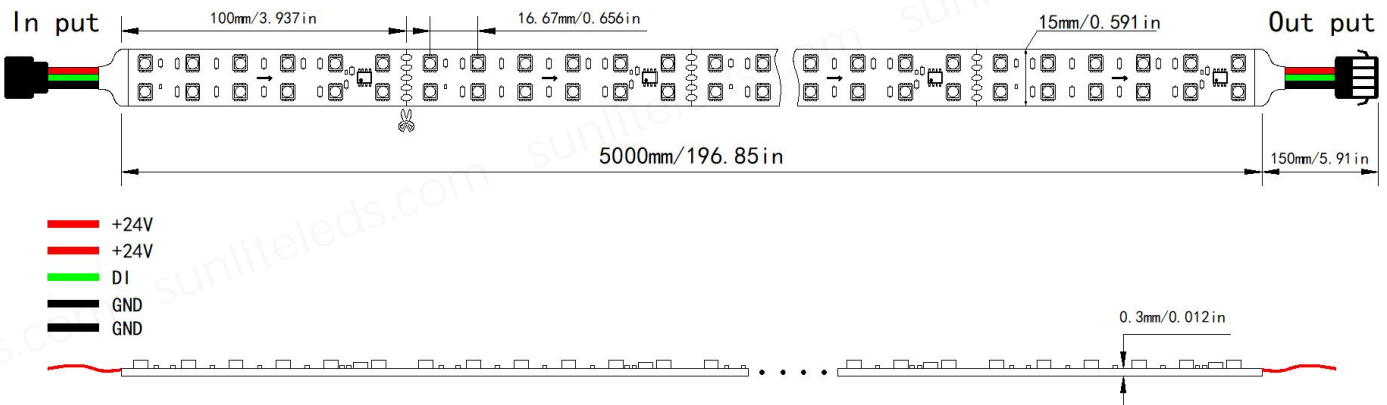

4. Product Specifications:

Item No	Voltage	Power Consumption	PCB Size	IP Rated	LED Qty	Color	Control Way	Break Continue
ST-UCS2903-5PIN-RGB -120-24V-20mm	DC24V	28.8w/m	5000*20*0.3mm	IP20/IP65/IP67	120led/m	RGB	TTL	No
ST-UCS2903-5PIN-RGB -120-24V-15mm	DC24V	28.8w/m	5000*15*0.3mm	IP20/IP65/IP67	120led/m	RGB	TTL	No

5. Production Application

It is widely used in wall corridor, indoor environment decoration, entertainment places, wine cabinet bar backlight, ceiling backlight, LED light box light source, LED luminous brand, aquarium supplies, car decoration and so on.



Video link:

<https://www.youtube.com/watch?v=RemZN-Xh42I&list=UUfDhsYs5eUtYJhkIRxVMQ9Q&index=60>

6. Control Diagram and Installation Diagram

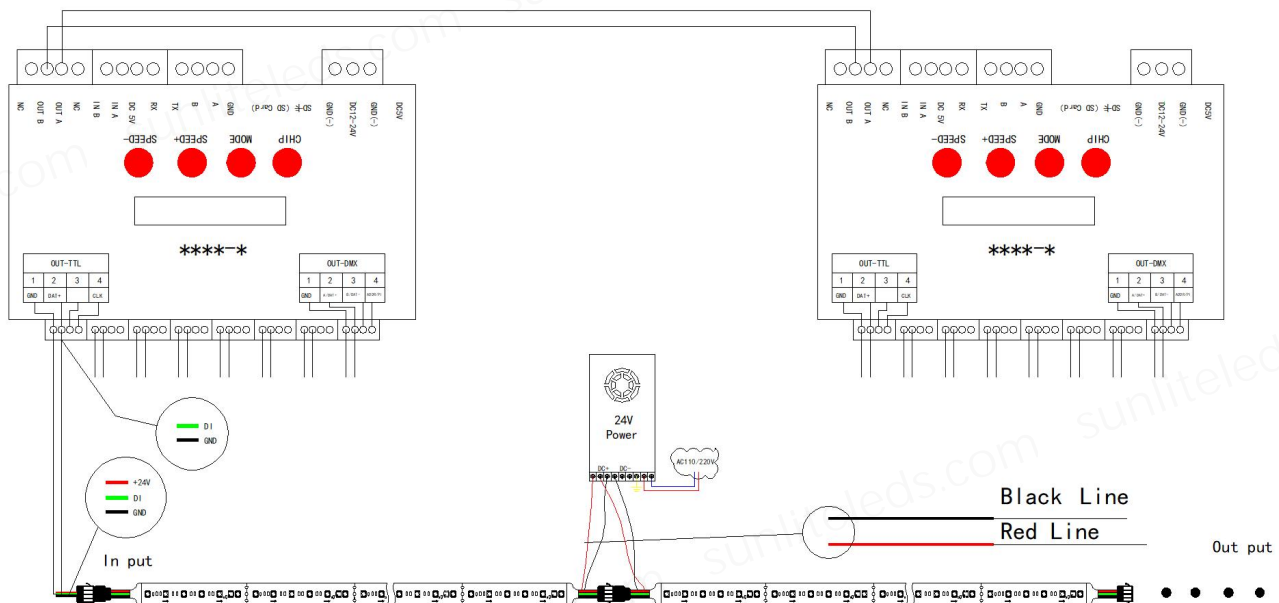

1. Madrix control

Recommended controller: T790K, YC3000

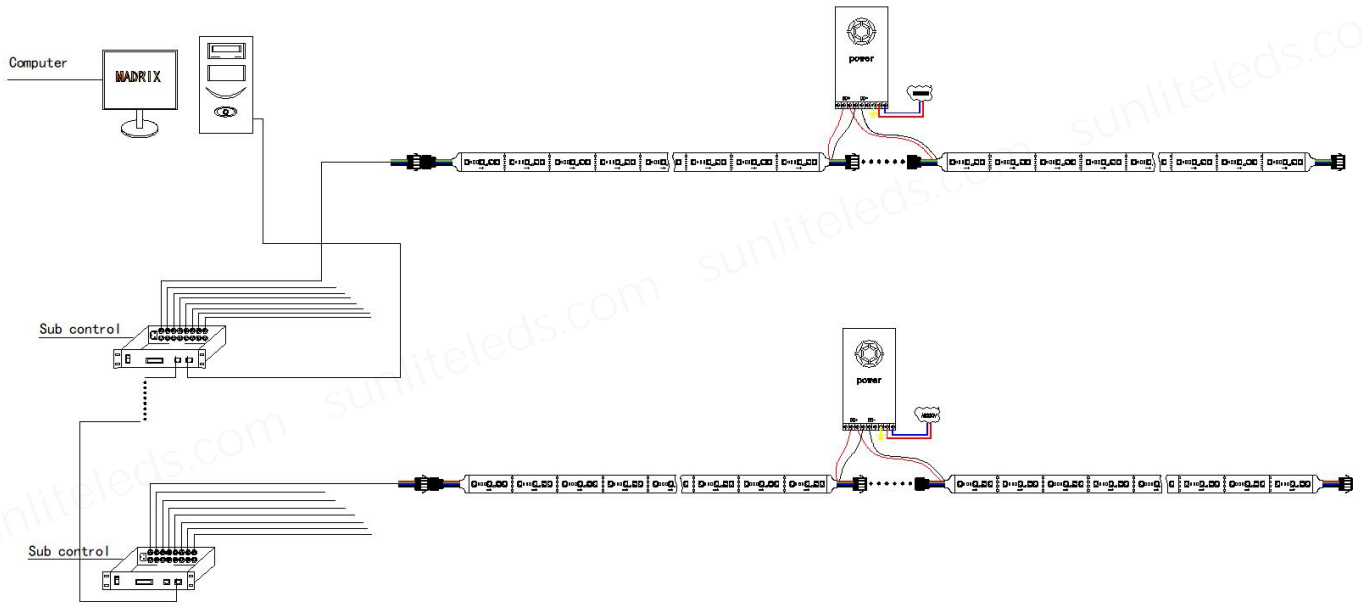

2. Online control by computer

Recommended controller: T-790K



3. Main controller + sub controller (Big project)

Recommended controller: Main controller: XB-Z2/MR-BF12B,

Sub controller : T-780K/MR-218DW

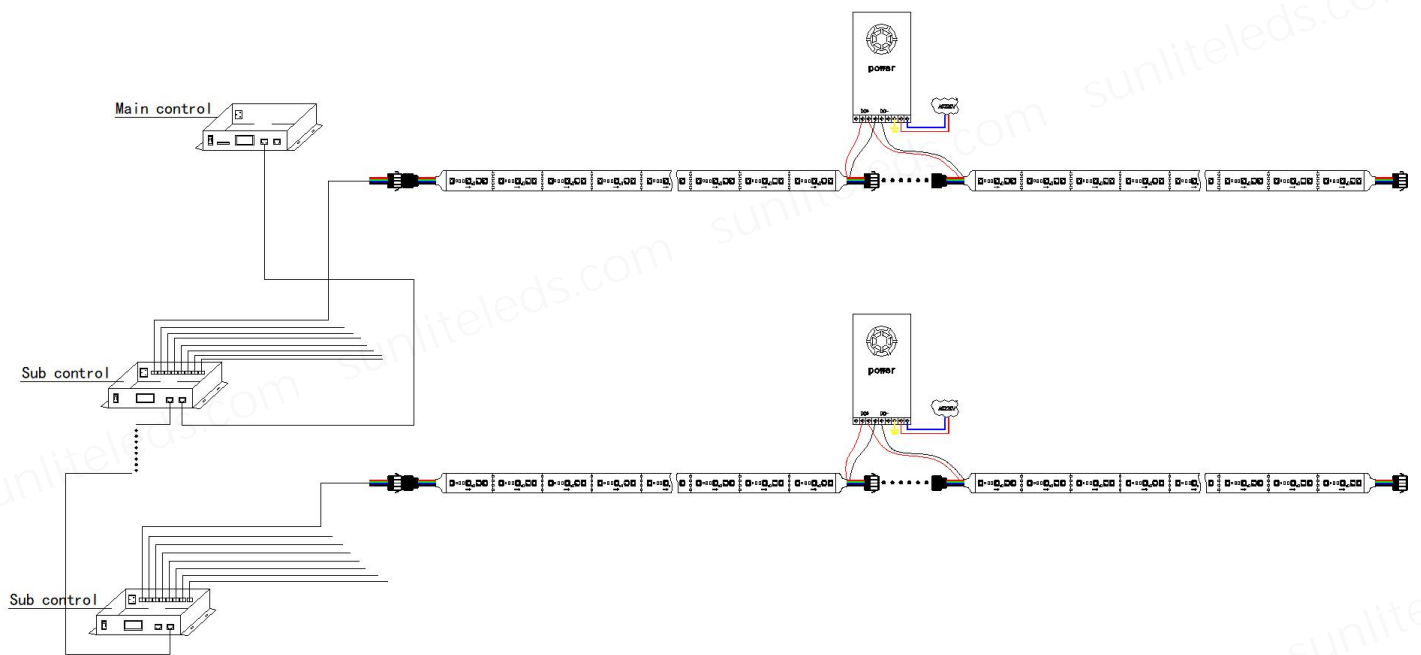

4. Built-in program Auto loop playback (Small project)

Recommended controller: K1000C, K8000C

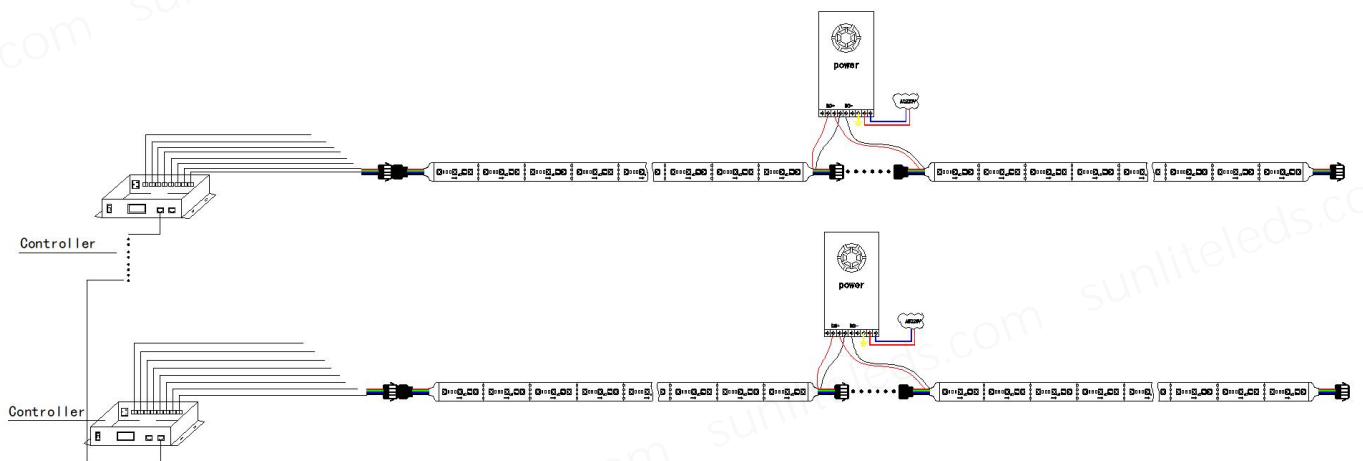

5. Mobile Phone APP connection diagram

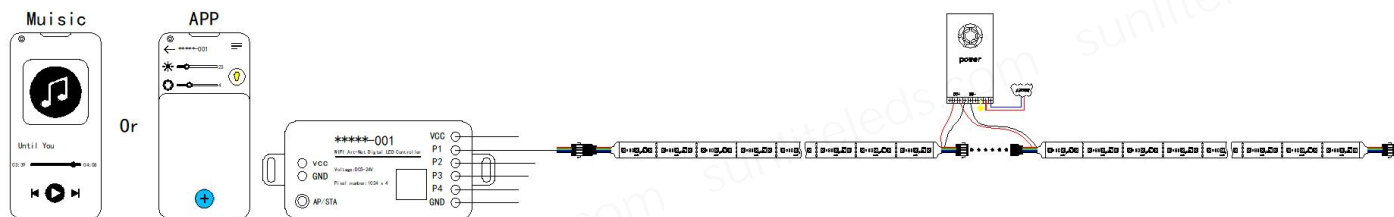

7. Installation Notes

- (1) Please read the manual in detail before installation.
- (2) Before installation, make sure that the working voltage of the LED strip light matches the output voltage of the switching power supply you purchased.
- (3) When installing, pay attention to the wiring label of the lamp. The red wire is connected to "positive (+)", the black wire is connected to "negative (-)", and other colors are detailed on the wiring label of the lamp. The wiring must be powered off during installation.
- (4) It is strictly forbidden to cut off the male and female head wires with electricity, so as not to burn out the lamps in the short-circuit.
- (5) LED strip light with control must comply with the male in and female out, and the direction of the signal must be connected in series when connecting the lamps.
- (6) This strip is forbidden to be disassembled without permission, if it is disassembled without permission, our company will not bear the warranty.

8. Simple troubleshooting

- (1) When the LED strip does not turn on when it is powered on: check whether the switching power supply has a working output voltage, or whether the working voltage of the switching power supply is normal.
- (2) After the switch power supply works normally, the lamp still does not light up: check whether the signal line of the lamp is connected incorrectly or whether the connection is normal, and check whether the controller works normally and whether it has been powered on.
- (3) The above work is normal, but the LED strip still does not light up: check whether the SD card of the controller has been inserted, and whether there is a program in the SD card.
- (4) The LED strip jumps or flickers: Check whether the negative pole of the lamp is connected in parallel with the negative pole of the switching power supply including the GND of the controller.
- (5) If the above inspection is completed, it is still out of control, please contact our sales staff to deal with it.