

Polarimeter (PMI-2000)

Our **NEW** user-friendly Liquid Crystal Stokes vector Polarimeter (PMI-2000) provides high accuracy and reliability in an easy-to-use instrument, suitable for manufacturing and laboratory applications. Our Polarimeter is a compact system with convenient computer control that accurately measures Stokes parameters 10 times per second. It quantifies the State of Polarization (SOP) and graphically displays the Poincaré Sphere, Polarization Ellipse, or running chart. The Meadowlark Optics system contains no spinning waveplates, motors, or other moving parts to wear or cause vibrations. Patented algorithms provide high accuracy and calibration versatility.

The controller of the Polarimeter PMI-2000 is integrated into the optical head. Temperature control and Stokes vector calculation are autonomously completed server-side in the Controller. This reduces the data volume of USB calls from PC to Controller.

The Stokes parameters comprise a four-component vector that completely characterizes the polarization of a light beam. The components of the Stokes vector are simple combinations of the intensity outputs from linear polarizers or circular polarizers.

The PolarVIEW software is a user-friendly interface which displays polarization data and allows the user to perform various operations:

- Display four Stokes parameters
- Readout temperature
- Display light levels
- Save function for continuous measurement mode

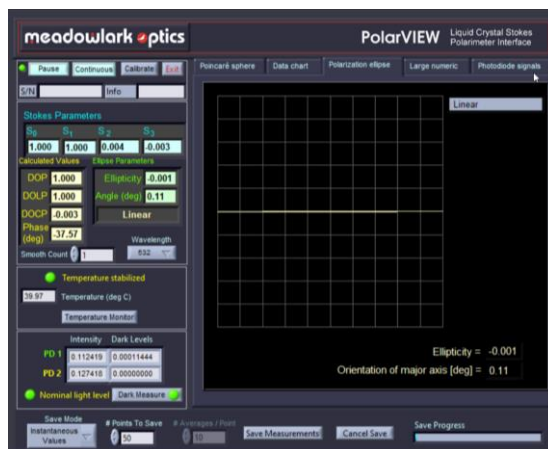
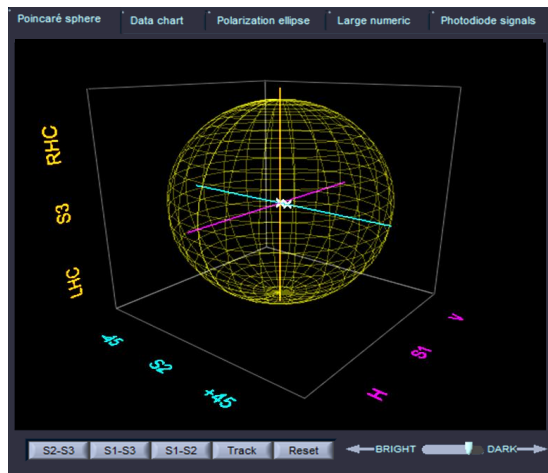

Key Features

- • •
- Compact
- No moving parts
- Broad wavelength range
- Versatile Configuration
- User-Friendly Operation
- High Sensitivity

Accessories

- • •
- Eigenstate Calibration Set
- Fiber Optic Adaptors

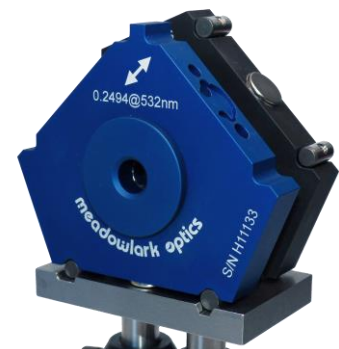



PMI-2000 SPECIFICATIONS

Wavelength Range	450 – 1100 nm, 900 – 1700 nm
Absolute Degree of Polarization Accuracy	≤ 1%
Measurable State of Polarization	Entire Poincaré Sphere
Measurement Frequency	10 Hz
Azimuth Accuracy	± 0.54°
Ellipticity Accuracy	± 0.008°
Warm-up Time for Rated Accuracy	15 minutes for 20°C room temperature
Minimum Optical Power to maintain accuracy*	10 μW
Resolution of Stokes vector components	0.001
Re-calibration Process	3 minutes, performed as needed with Eigenstate Calibration Set
Input Aperture	2 mm diameter, knife edge
Input Fiber Connector	Optional, 11 mm diameter
Fiber Coupling Adaptor	Optional
Maximum Operating Temperature	35°C
Input Power Supply	12 V, 2A
Power Supply Ratings	Includes 5 plugs for different regions
Optical Head Dimensions	55.88 mm (W) x 76.20 mm (H) x 69.34 mm (L)
Command and Control Interface	USB 2.0 Micro A

These specifications describe performance at 23 ± 3 °C ambient temperature.

*sensitivity can be increased to 1 μW by special request

PMI-2000 ORDERING INFORMATION

<i>Wavelength Range</i>	<i>Version</i>	<i>Part Number</i>
450 – 1100 (nm)	Visible	PMI2 – VIS
900 – 1700 (nm)	Near Infrared	PMI2 – NIR



Eigenstate Calibration Set

The polarimeter comes pre-calibrated with up to three wavelengths. The Eigenstate Calibration Set makes additional recalibrations easy. Due to changes in environmental conditions and laboratory configurations, recalibration may be necessary. The PolarVIEW software gives step-by-step instructions in pictorial format. Basic knowledge of polarization optics isn't necessary when using the Eigenstate Set.

The Eigenstate Calibration Set produces six polarization eigenstates: linear polarized light at angles of 0, 90, +45, -45 degrees as well as circular right-handed and circular left-handed polarized light. These states are created by using a wire grid beam splitting polarizer and a precision superachromatic quarter waveplate. The housings are CNC machined so that the accuracy of the angles is better than 1 arc minute. Pins on the housings mate to a v-groove and a flat groove in a quasi-kinematic fashion, while magnets provide holding force. This scheme facilitates precise, simple and fast indexing of the polarization eigenstates. Large arrows on the housing indicate the transmission axis of the polarizer and the fast axis of the waveplate for ease of use.

Poincaré Sphere showing six polarization eigenstates

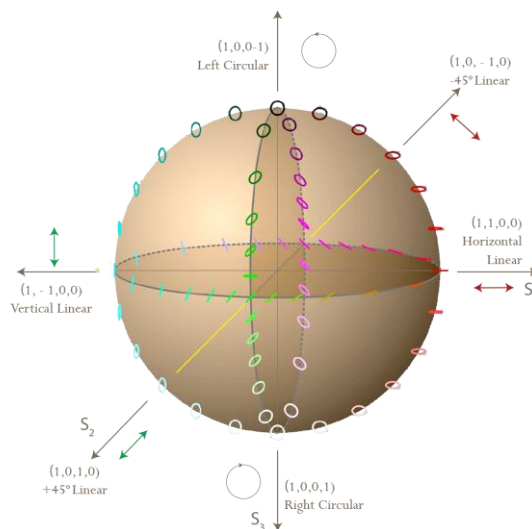

BROADBAND EIGENSTATE CALIBRATION SET SPECIFICATIONS

Wavelength Range – VIS/NIR	450 – 1100 nm
Wavelength Range – IR	900 – 1700 nm
Retardance Accuracy	$\lambda/50$
Thickness	1.10 ± 0.02 in (27.94 ± 0.51 mm)
Clear Aperture	Retarder: 0.400 in (10.0 mm) Polarizer: 0.315 in (8.0 mm)

ORDERING INFORMATION FOR CALIBRATION SETS (POLARIZER AND RETARDER)

<i>Item</i>	<i>Part Number</i>
Broadband Eigenstate Calibration Set – VIS/NIR	ECS – 450 – 1100
Broadband Eigenstate Calibration Set – IR	ECS – 900 – 1700

ORDERING INFORMATION FOR CALIBRATION RETARDERS OR POLARIZERS (INDIVIDUAL COMPONENTS)

Broadband Eigenstate Polarizer	EGP – 450 – 1700
Achromatic Eigenstate Retarder – VIS/NIR	EGR – 450 – 1100
Achromatic Eigenstate Retarder – IR	EGR – 900 – 1700



Polarimeter

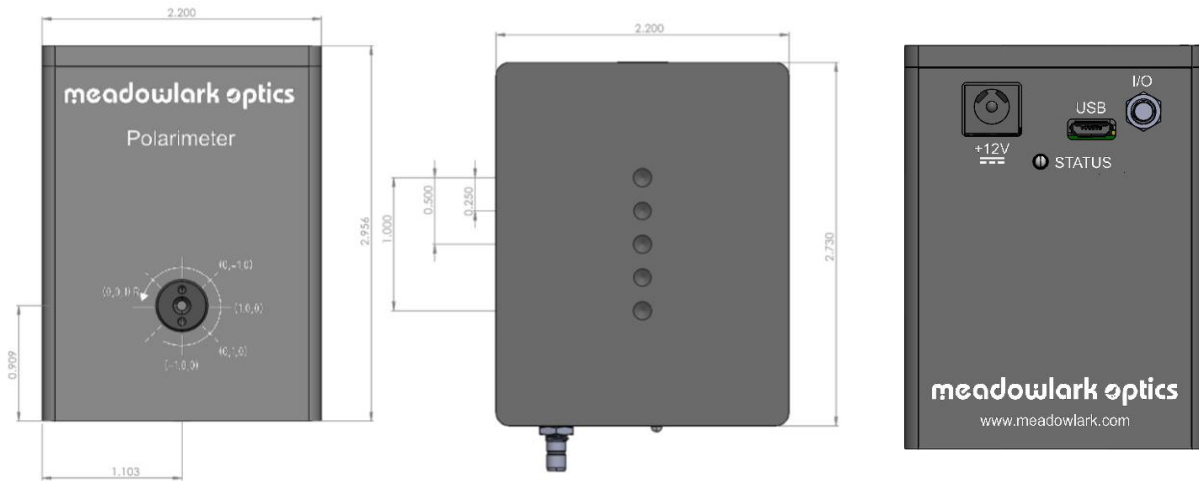

Broadband Eigenstate Set

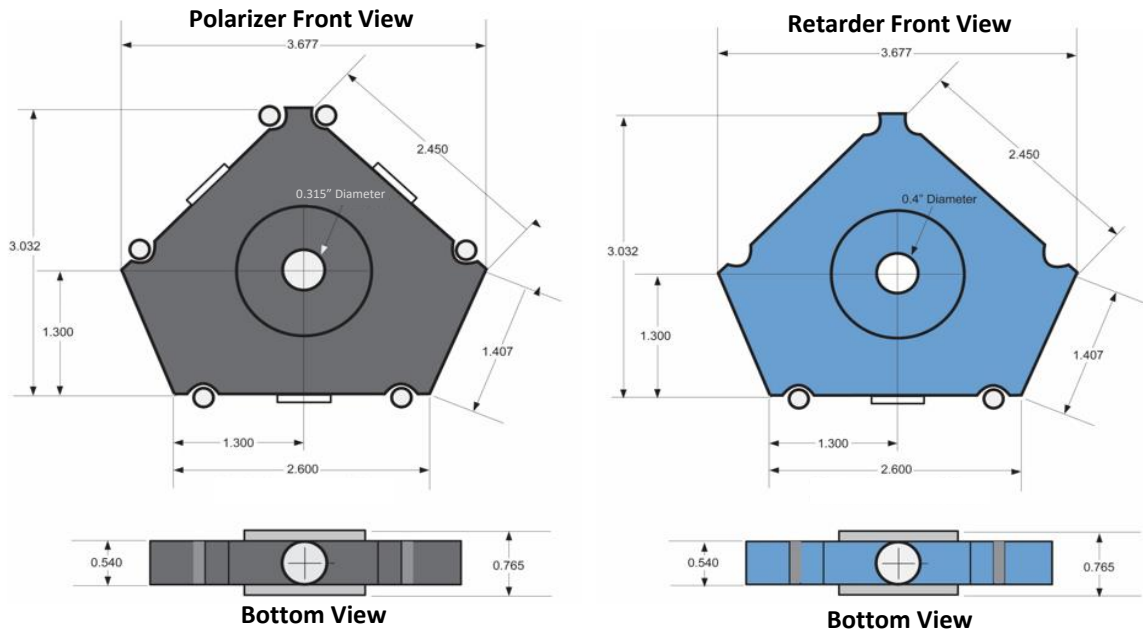

Eigenstate Baseplate

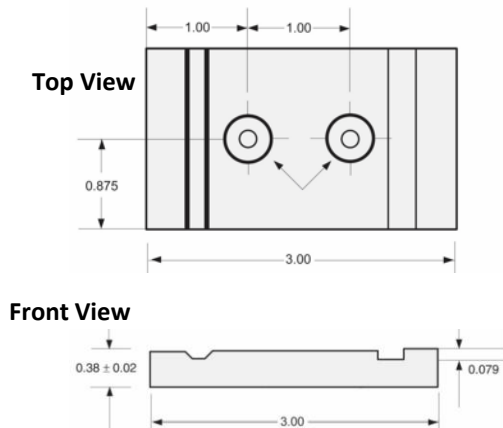

Calibration Sequence	Stokes Vector	SOP Description	Polarizer Orientation	Waveplate Orientation
Step 1	(1,1,0,0)	Horizontal		Removed
Step 2	(1,-1,0,0)	Vertical		Removed
Step 3	(1,0,1,0)	+45°		Removed
Step 4	(1,0,-1,0)	-45°		Removed
Step 5	(1,0,0,1)	Right Circular		
Step 6	(1,0,0,-1)	Left Circular		

Polarimeter calibration is greatly simplified by the Eigenstate Calibrator sequence outlined above