

Waveform Processing Airborne LiDAR Scanning System for High Point Density Mapping and Ultra-Wide Area Mapping

RIEGL VQ[®]-1460

- **high pulse repetition rates of up to 4.4 MHz**
- **up to 2.93 million measurements per second on the ground**
- **best point distribution for optimum target resolution**
- **excellent atmospheric clutter suppression**
- **multiple target capability**
- **online waveform processing and full waveform data recording**
- **on-board graphical user interface for easy access to primary scanner parameters**
- **integrated inertial measurement unit and GNSS receiver**
- **prepared for the integration of up to two high resolution RGB/NIR cameras**
- **optimized for interfacing with typical hatches and stabilized platforms**
- **deteachable handgrips for facilitated handling**

The VQ-1460 is one of RIEGL's latest high-end airborne laser scanning systems, suitable for a wide field of applications – from high-point density wide area mapping to ultra-high resolution city mapping or corridor mapping.

The unique design features pulse repetition rates from 4.4 MHz, resulting in a regular point spacing and an almost constant point density distribution on the ground. For a target reflectance of 20 %, the system features large measurement distances of up to 5400 m at a minimum PRR of 540 kHz and of up to 2300 m at a maximum PRR of 4.4 MHz, resulting in an unsurpassed high efficiency in area acquisition of e.g., up to 615 km²/h at 150 knots flying speed for an average of 8 points per square meter.

A newly designed optical fronted significantly minimizes for near-range echoes due to atmospheric clutter, resulting in clean point clouds. Online-Waveform processing and full-waveform processing capabilities are a matter of course for this class of equipment.

Scan data and camera images are stored on removable hard disks that can be accessed directly on the device, eliminating the need for an external data recorder.

A high-performance IMU/GNSS unit and one or two optional high-resolution RGB/NIR cameras are seamlessly integrated in the compact and user-friendly designed housing. The standardized mounting flange fits typical hatches or gyro-stabilized leveling mounts for maintaining optimum point distribution.

Applications:

- *Ultra Wide Area / High Altitude Mapping*
- *Ultra-High Point Density Mapping*
- *Mapping of Complex Urban Environments*
- *Glacier & Snowfield Mapping*
- *City Modeling*
- *Mapping of Lakesides & River Banks*
- *Agriculture & Forestry*
- *Corridor Mapping*

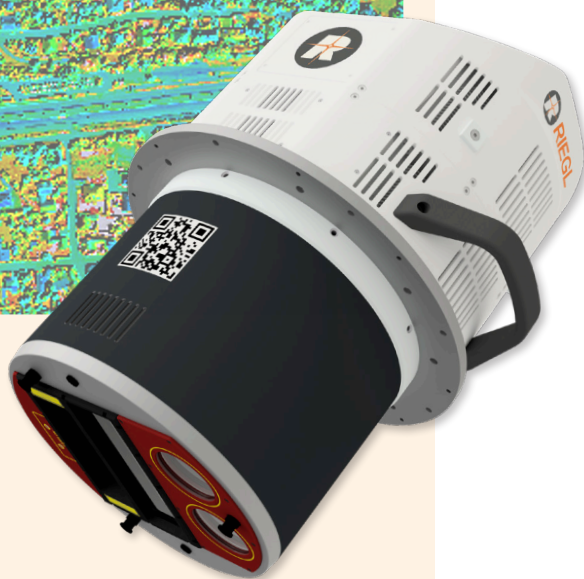

visit our website
www.riegl.com



RIEGL VQ[®]-1460 Dense Scan Pattern and Wide Effective Swath Width

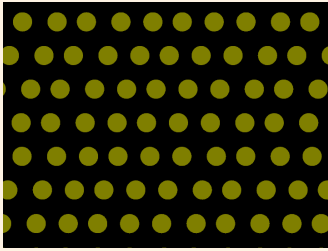

RIEGL VQ-1460 point distribution

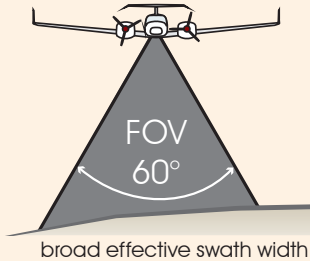

The RIEGL VQ-1460 scanning mechanism – based on a continuously rotating polygon mirror wheel – delivers straight parallel scan lines resulting in a regular point pattern on the ground. With equal spatial sampling frequency along and across track, object extents are well defined and even small objects may be detected. The instrument is perfectly suited for applications where a superior point pattern on target surfaces is required.

The wide field of view and the multiple-time-around measurement capability of the RIEGL VQ-1460 make the instrument perfectly suited for wide area mapping applications. The instrument has been designed for utmost efficiency in collecting data by enabling scanning operations from high altitudes at high laser pulse repetition rates simultaneously, reducing the necessary flight time to a minimum.

RIEGL VQ-1460 Elements of Function and Operation

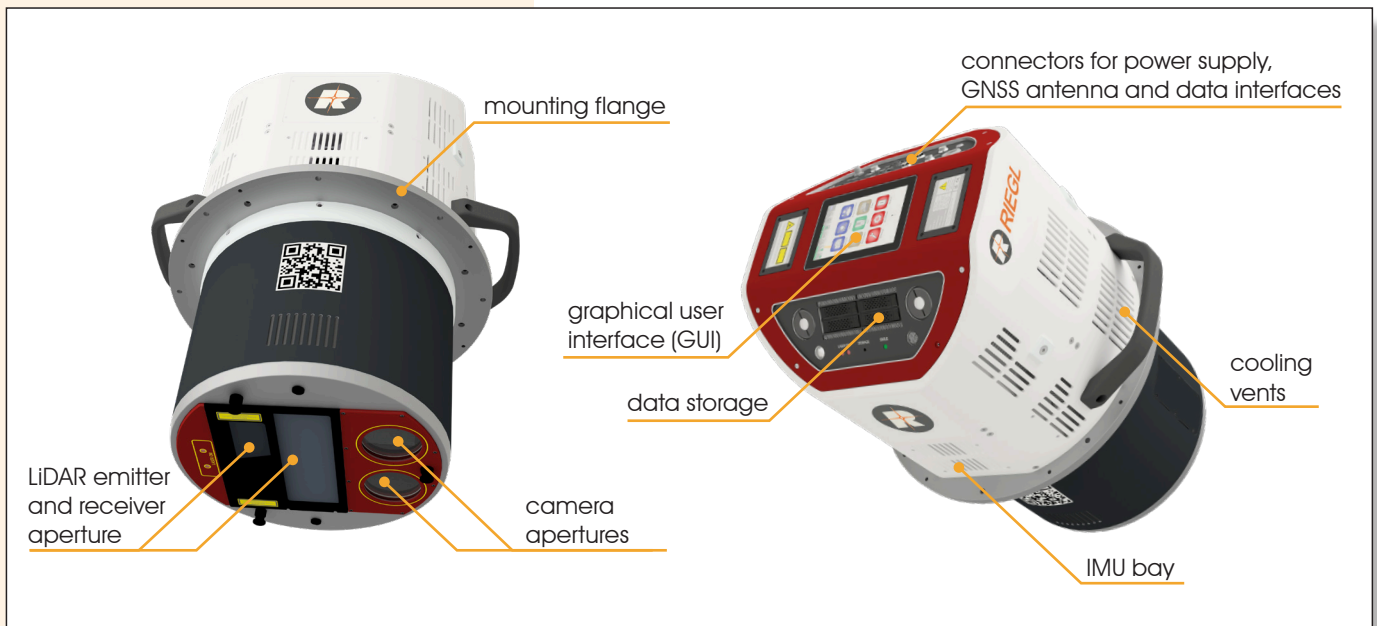

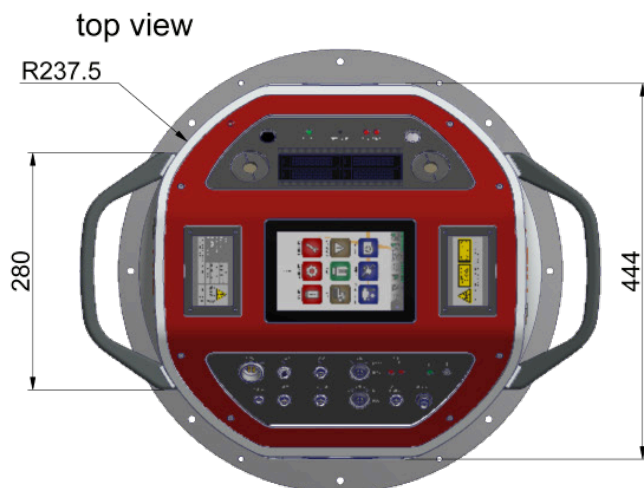
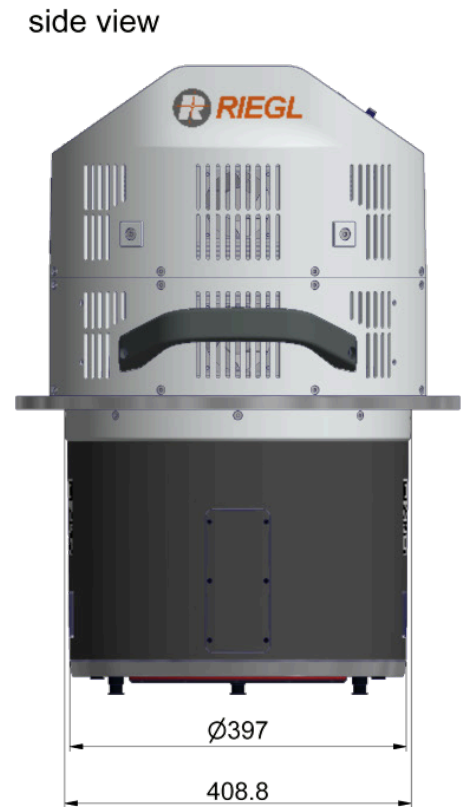
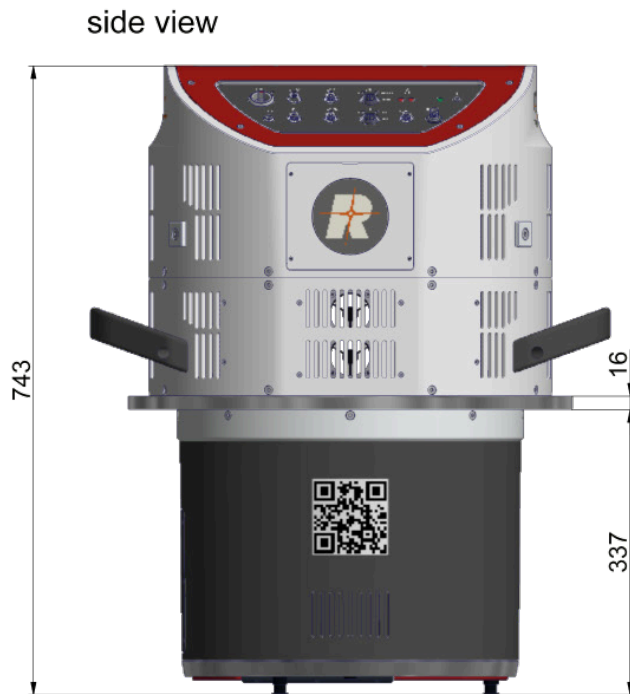
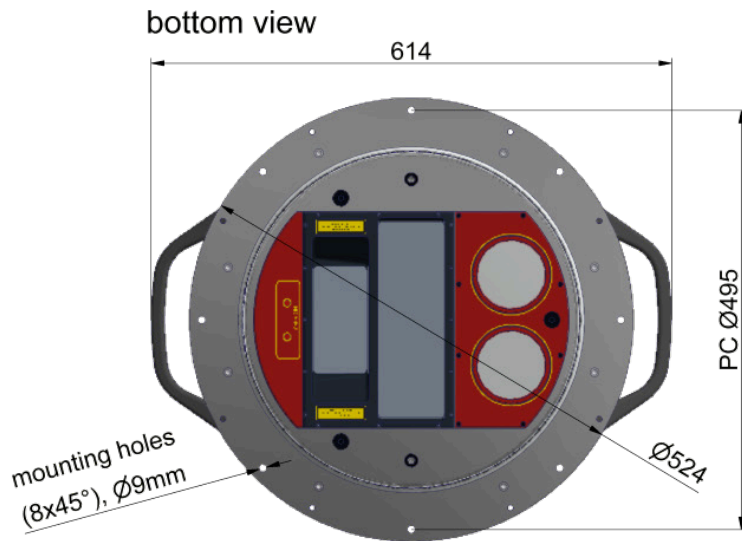

dimensions in mm

RIEGL VQ-1460 System Components

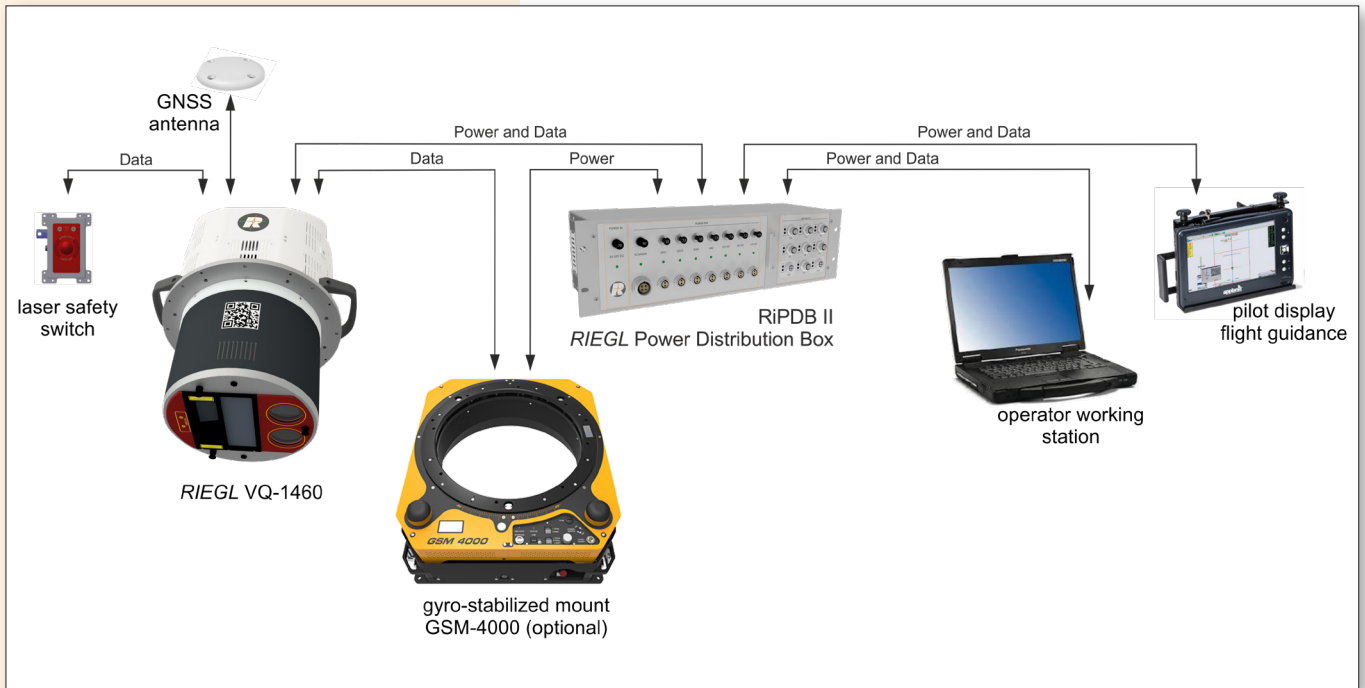

A minimum number of system components and external cabling is required for an easy and quick installation in aircrafts.

RIEGL VQ-1460 Installation Examples



RIEGL VQ-1460 installed in the nose pod of fixed-wing aircraft DA42 MPP



RIEGL VQ-1460 installed on GSM-4000 gyro-stabilized platform to be used in a helicopter or fixed-wing aircraft

Measurement Range & Point Density RIEGL VQ-1460

Laser Pulse Repetition Rate = 2x270kHz, laser power level 100%

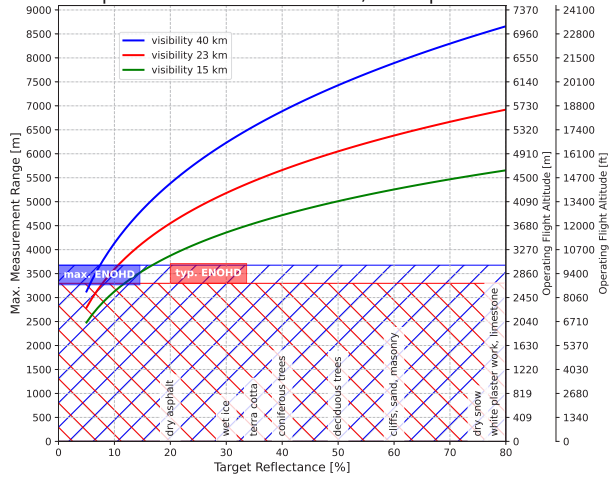

Example: VQ-1460 at 2 x 270,000 pulses/sec, laser power level 100%
altitude 12,000 ft AGL, speed 160 kn

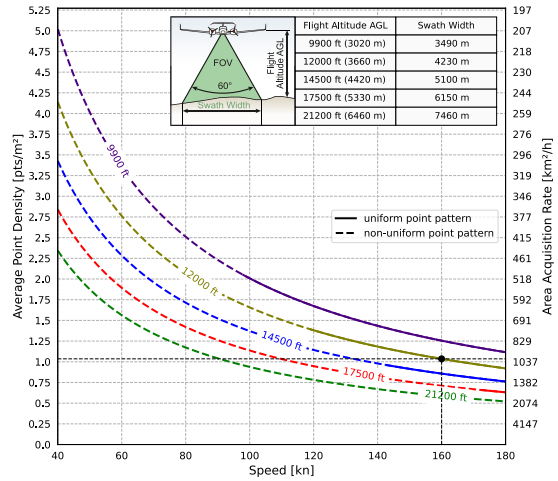

Results: point density ~ 1.04 pts/m²
area acquisition rate ~ 1001 km²/h

Laser Pulse Repetition Rate = 2x500kHz, laser power level 100%

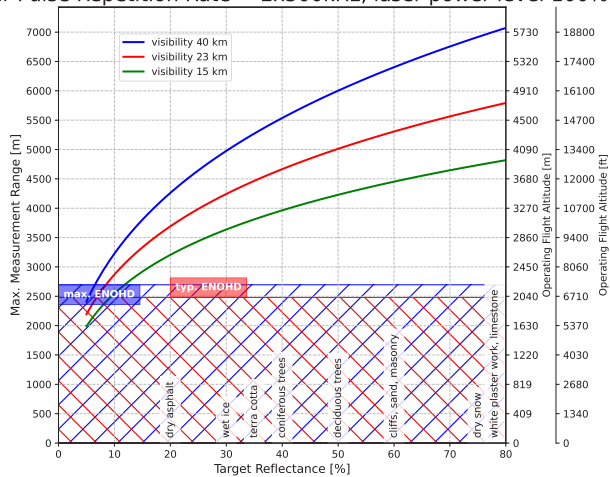

Example: VQ-1460 at 2 x 500,000 pulses/sec, laser power level 100%
altitude 11,200 ft AGL, speed 140 kn

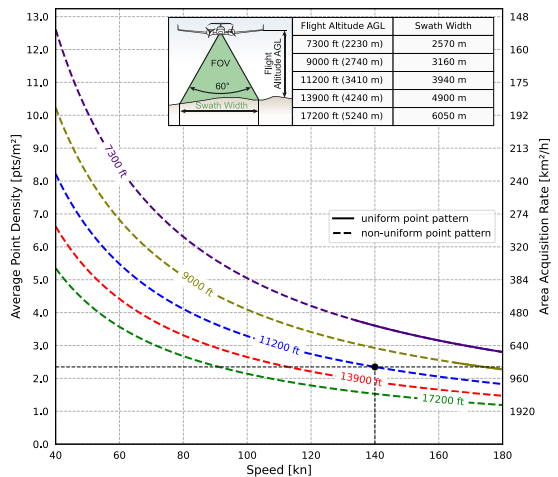

Results: point density ~ 2.35 pts/m²
area acquisition rate ~ 818 km²/h

Laser Pulse Repetition Rate = 2x1000kHz, laser power level 100%

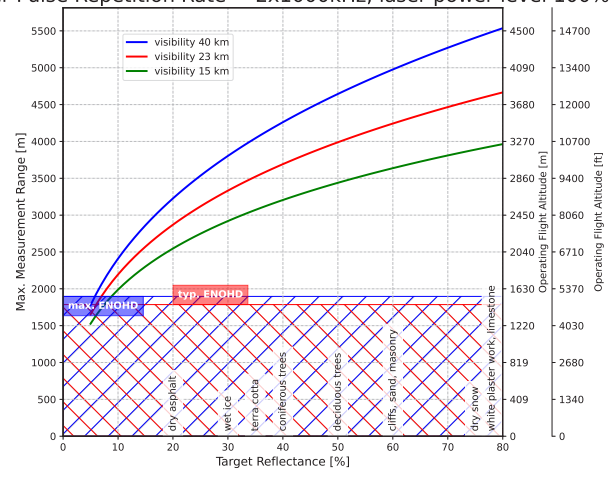

Example: VQ-1460 at 2 x 1,000,000 pulses/sec, laser power level 100%
altitude 5,100 ft AGL, speed 110 kn

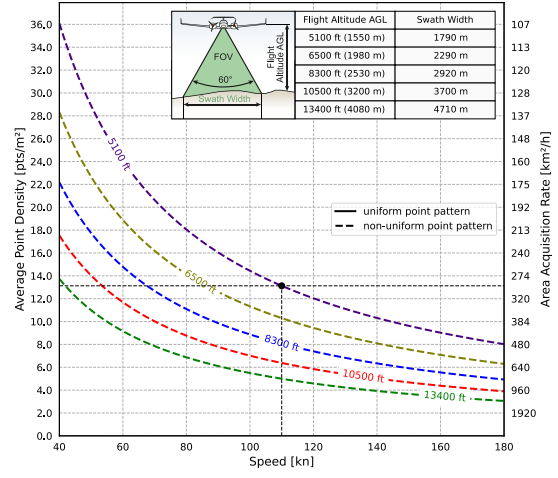

Results: point density ~ 13.13 pts/m²
area acquisition rate ~ 293 km²/h

The following conditions are assumed for the Operating Flight Altitude AGL

- ambiguity resolved by multiple-time-around (MTA) processing
- target size ≥ laser footprint
- effective FOV 60°
- average ambient brightness
- roll angle up to ±5°

Assumptions for calculation of the Area Acquisition Rate

- 20% overlap of neighboring flight strips. This overlap covers a roll angle of ±5° or a reduction of flight altitude AGL of 20%.

Typical ENOHD

- Calculated under assumption of an angular step width of 0.012° and an aircraft speed higher than 10 kn.

Measurement Range & Point Density RIEGL VQ-1460

Laser Pulse Repetition Rate = 2x2200kHz, laser power level 100%

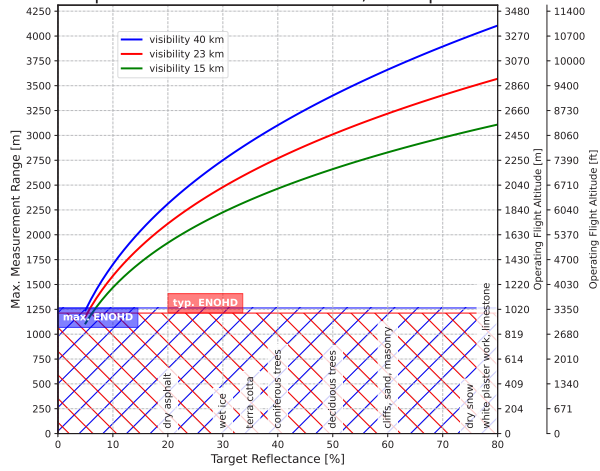

Example: VQ-1460 at 2 x 2,200,000 pulses/sec, laser power level 100%
altitude 5,800 ft AGL, speed 170 kn

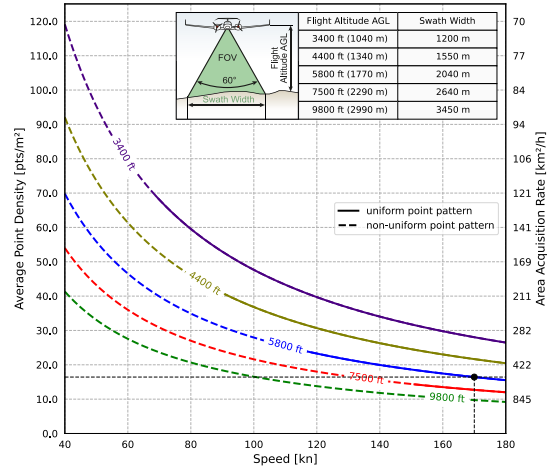

Results: point density ~ 16.43 pts/m²
area acquisition rate ~ 514 km²/h

Laser Pulse Repetition Rate = 2x2200kHz, laser power level 50%

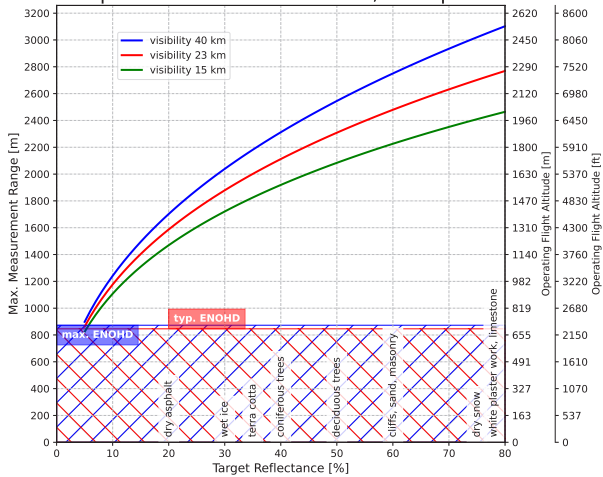

Example: VQ-1460 at 2 x 2,200,000 pulses/sec, laser power level 50%
altitude 5,600 ft AGL, speed 150 kn

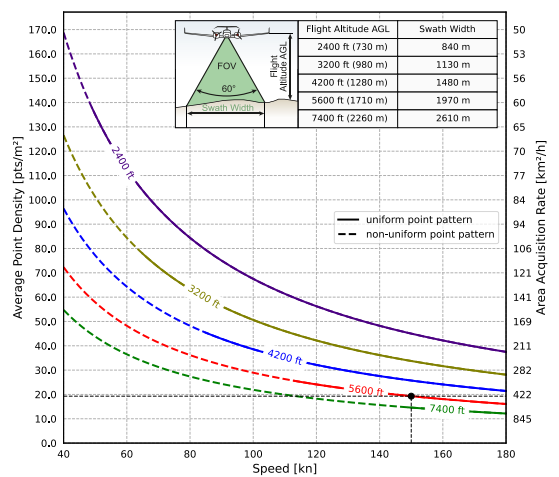

Results: point density ~ 19.29 pts/m²
area acquisition rate ~ 438 km²/h

Laser Pulse Repetition Rate = 2x2200kHz, laser power level 25%

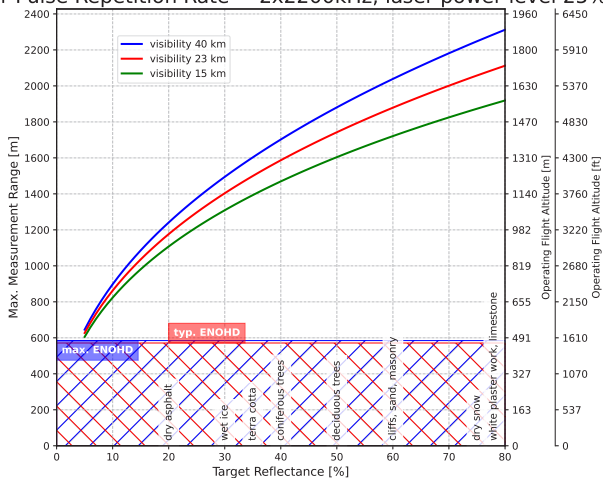

Example: VQ-1460 at 2 x 2,200,000 pulses/sec, laser power level 25%
altitude 3,000 ft AGL, speed 120 kn

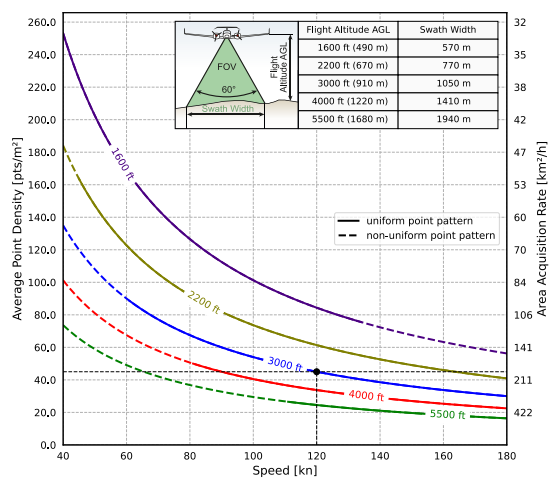

Results: point density ~ 45 pts/m²
area acquisition rate ~ 188 km²/h

The following conditions are assumed for the Operating Flight Altitude AGL

- ambiguity resolved by multiple-time-around (MTA) processing
- target size ≥ laser footprint
- effective FOV 60°
- average ambient brightness
- roll angle up to ±5°

Assumptions for calculation of the Area Acquisition Rate

- 20% overlap of neighboring flight strips. This overlap covers a roll angle of ±5° or a reduction of flight altitude AGL of 20%.

Typical ENOHD

- Calculated under assumption of an angular step width of 0.012° and an aircraft speed higher than 10 kn.

Measurement Range & Point Density RIEGL VQ-1460

Laser Pulse Repetition Rate = 2x2200kHz, laser power level 12%

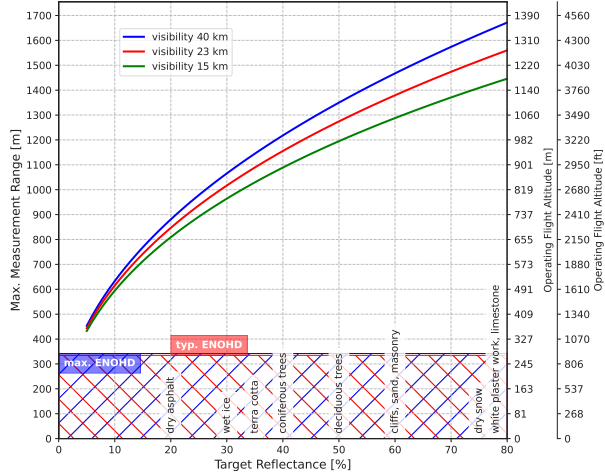

Example: VQ-1460 at 2 x 2,200,000 pulses/sec, laser power level 12%
altitude 2,800 ft AGL, speed 115 kn

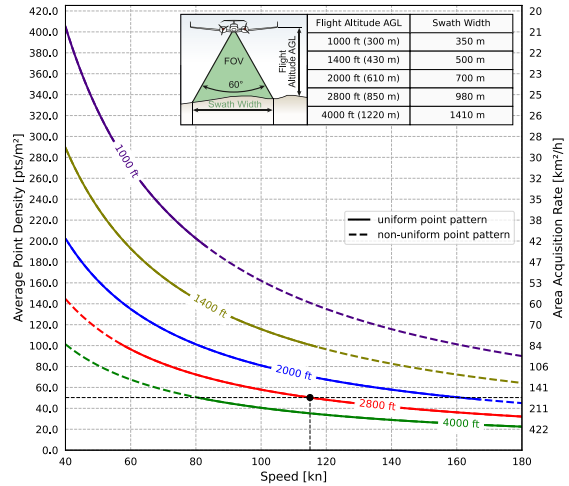

Results: point density ~ 50.31 pts/m²
area acquisition rate ~ 168 km²/h

Laser Pulse Repetition Rate = 2x2200kHz, laser power level 6%

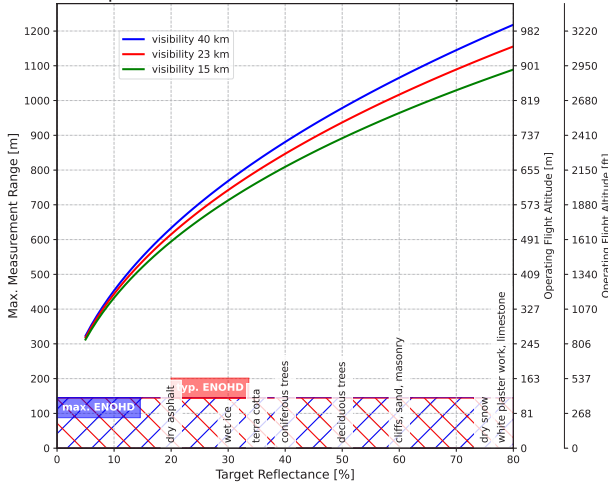

Example: VQ-1460 at 2 x 2,200,000 pulses/sec, laser power level 6%
altitude 2,800 ft AGL, speed 100 kn

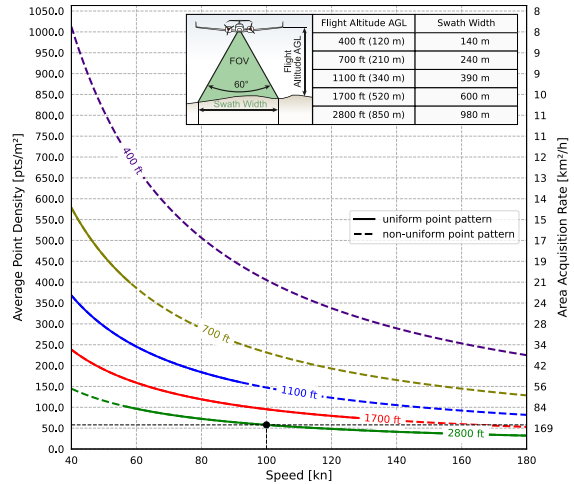

Results: point density ~ 57.86 pts/m²
area acquisition rate ~ 146 km²/h

The following conditions are assumed for the Operating Flight Altitude AGL

- ambiguity resolved by multiple-time-around (MTA) processing
- target size ≥ laser footprint
- effective FOV 60°
- average ambient brightness
- roll angle up to ±5°

Typical ENOHD

- Calculated under assumption of an angular step width of 0.012° and an aircraft speed higher than 10 kn.

Assumptions for calculation of the Area Acquisition Rate

- 20% overlap of neighboring flight strips. This overlap covers a roll angle of ±5° or a reduction of flight altitude AGL of 20%.

RIEGL VQ-1460 Productivity

The RIEGL VQ-1460 Waveform Processing Airborne LiDAR Mapping System offers highest productivity.

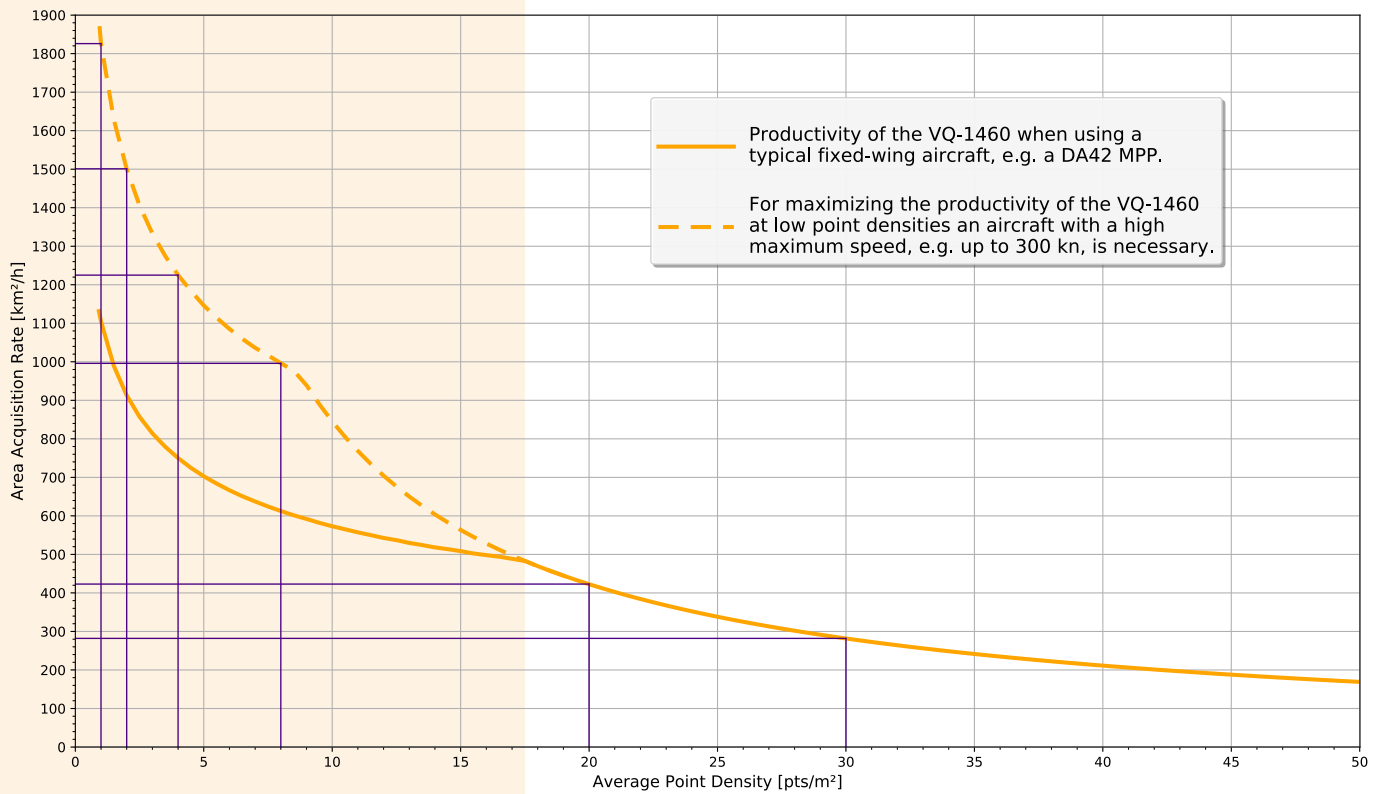

Examples ¹⁾						
Average Point Density	1 pts/m ²	2 pts/m ²	4 pts/m ²	8 pts/m ²	20 pts/m ²	30 pts/m ²
Flight Altitude	11670 ft 3560 m	9590 ft 2920 m	7830 ft 2390 m	6370 ft 1940 m	5400 ft 1650 m	3600 ft 1100 m
Ground Speed	300 kn	300 kn	300 kn	300 kn	150 kn	150 kn
Swath Width	4110 m	3380 m	2760 m	2240 m	1900 m	1270 m
Productivity	1826 km ² /h	1501 km ² /h	1225 km ² /h	996 km ² /h	423 km ² /h	282 km ² /h
eff. Measurement Rate ²⁾	634,000 meas./sec	1,042,000 meas./sec	1,702,000 meas./sec	2,767,000 meas./sec	2,935,000 meas./sec	2,935,000 meas./sec
Camera GSD ^{3) 4)}	269 mm	220 mm	180 mm	146 mm	125 mm	83 mm
Camera Trigger Intervall ⁴⁾	6.9 sec	5.7 sec	4.6 sec	3.8 sec	6.4 sec	4.3 sec

1) calculated for 20% target reflectivity and 20% stripe overlap
 2) The target detection rate is equal to the measurement rate for terrains offering only one target per laser pulse but may be much higher for vegetated areas.
 3) Ground Sampling Distance
 4) calculated for a 150 MPixel CMOS camera with a FOV of 56.2° x 43.7° and 60% image overlap in flight direction (endlap).

Laser Product Classification

Class 4 Laser Product according to IEC60825-1:2014
The following clause applies for instruments delivered into the United States: Complies with 21 CFR 1040.10 and 1040.11 except for conformance with IEC 60825-1 Ed.3., as described in Laser Notice No. 56, dated May 8, 2019.

The instrument must be used only in combination with the appropriate laser safety box.



Range Measurement Performance

as a function of laser power setting, PRR, and target reflectivity

Laser Power Level	100%			
Laser Pulse Repetition Rate (PRR) ¹⁾	2 x 270 kHz	2 x 500 kHz	2 x 1000 kHz	2 x 2200 kHz
Max. Measuring Range ^{2) 3) 4)}				
natural targets $\rho \geq 20\%$	5400 m	4250 m	3250 m	2300 m
natural targets $\rho \geq 60\%$	7900 m	6400 m	5000 m	3650 m
Max. Operating Flight Altitude ^{2) 5)} (AGL) ⁶⁾				
natural targets $\rho \geq 20\%$	4400 m 14450 ft	3500 m 11450 ft	2650 m 8650 ft	1900 m 6200 ft
natural targets $\rho \geq 60\%$	6450 m 21200 ft	5250 m 17200 ft	4100 m 13400 ft	3000 m 9850 ft
NOHD ^{7) 9)}	421 m (414 m ¹⁰⁾)	309 m (305 m ¹⁰⁾)	217 m (215 m ¹⁰⁾)	143 m (142 m ¹⁰⁾)
ENOHD ^{8) 9)}	3011 m (2701 m ¹⁰⁾)	2208 m (2032 m ¹⁰⁾)	1554 m (1463 m ¹⁰⁾)	1035 m (993 m ¹⁰⁾)
Number of Targets per Laser Pulse up to ¹¹⁾	31	31	15	7

Laser Power Level	50%	25%	12%	6%
Laser Pulse Repetition Rate (PRR) ¹⁾	2 x 2200 kHz	2 x 2200 kHz	2 x 2200 kHz	2 x 2200 kHz
Max. Measuring Range ^{2) 3) 4)}				
natural targets $\rho \geq 20\%$	1700 m	1250 m	900 m	650 m
natural targets $\rho \geq 60\%$	2750 m	2050 m	1450 m	1050 m
Max. Operating Flight Altitude ^{2) 5)} (AGL) ⁶⁾				
natural targets $\rho \geq 20\%$	1400 m 4450 ft	1000 m 3350 ft	700 m 2350 ft	500 m 1700 ft
natural targets $\rho \geq 60\%$	2250 m 7400 ft	1650 m 5500 ft	1200 m 3950 ft	850 m 2850 ft
NOHD ^{7) 9)}	97 m (97 m ¹⁰⁾)	63 m (63 m ¹⁰⁾)	30 m (30 m ¹⁰⁾)	15 m (15 m ¹⁰⁾)
ENOHD ^{8) 9)}	715 m (693 m ¹⁰⁾)	479 m (468 m ¹⁰⁾)	280 m (274 m ¹⁰⁾)	119 m (118 m ¹⁰⁾)
Number of Targets per Laser Pulse up to ¹¹⁾	7	7	7	7

- 1) rounded average PRR
- 2) Typical values for average conditions and average ambient brightness; in bright sunlight the operational range may be considerably shorter and the operational flight altitude may be considerably lower than under an overcast sky.
- 3) The maximum range is specified for flat targets with size in excess of the laser beam diameter, perpendicular angle of incidence, and for atmospheric visibility of 40 km. Range ambiguities have to be resolved by multiple-time-around processing.
- 4) If the laser beam hits, in part, more than one target, the laser's pulse power is split accordingly. Thus, the achievable range is reduced.
- 5) Typical values for max. effective FOV 60°, additional roll angle up to $\pm 5^\circ$
- 6) Above Ground Level
- 7) Nominal Ocular Hazard Distance, based upon MPE according to IEC 60825-1:2014, for single line condition
- 8) Extended Nominal Ocular Hazard Distance, based upon MPE according to IEC 60825-1:2014, for single line condition
- 9) NOHD and ENOHD have been calculated for a typical angular step width of 0.013° (which means non-overlapping laser footprints), and an aircraft speed higher than 10 kn. NOHD and ENOHD increase when using overlapping laser footprints which may be intended e.g. for power line mapping.
- 10) The atmospheric attenuation of the laser beam is taken into account assuming standard clear conditions with a visibility of 23.5 km. Absorption by water vapor and carbon dioxide is neglected.
- 11) when using online waveform processing

Minimum Range ¹²⁾	100 m
Accuracy ^{13) 14)} / Precision ^{14) 15)}	20 mm / 20 mm
Laser Pulse Repetition Rate	540 kHz up to 4.4 MHz, selectable in steps of less than 1%
Effective Measurement Rate	up to 2.93 MHz @ 60° scan angle
Echo Signal Intensity	provided for each echo signal
Laser Wavelength	near infrared
Laser Beam Divergence	typ. 0.17 mrad @ 1/e ¹⁶⁾ , typ. 0.23 mrad @ 1/e ² ¹⁷⁾

Scanner Performance

Scanning Mechanism	rotating polygon mirror
Scan Pattern	parallel scan lines
Scan Angle Range	60°
Total Scan Rate	72 ¹⁸⁾ - 600 lines/sec
Angular Step Width $\Delta\theta$	0.006° $\leq \Delta\theta \leq 0.1^\circ$ ^{19) 20)}
Angle Measurement Resolution	0.001°

- 12) Limitation for range measurement capability, does not consider laser safety issues! The minimum range for valid reflectivity values is 250 m.
- 13) Accuracy is the degree of conformity of a measured quantity to its actual (true) value.
- 14) Standard deviation one sigma @ 250 m range under RIEGL test conditions.
- 15) Precision, also called reproducibility or repeatability, is the degree to which further measurements show the same result.

- 16) Measured at the 1/e points. 0.17 mrad correspond to an increase of 17 cm of beam diameter per 1000 m distance.
- 17) Measured at the 1/e² points. 0.23 mrad correspond to an increase of 23 cm of beam diameter per 1000 m distance.
- 18) The minimum scan rate depends on the selected laser PRR.

- 19) The minimum angular step width depends on the selected laser PRR.
- 20) The maximum angular step width is limited by the maximum scan rate.

Technical Data to be continued at page 10

Technical Data RIEGL VQ-1460 *(continued)*

Data Interfaces

Configuration
Scan Data Output
Synchronization

LAN 10/100/1000/2500/5000/10000 MBit/s
LAN 10/100/1000/2500/5000/10000 MBit/s
Serial RS-232 interface, TTL input for 1 pps synchronization pulse, accepts different data formats for GNSS-time information
2 connectors with power, RS-232, pps, trigger, exposure
2x U.2 SSD, up to 15.36 TByte each

Camera Interface
Removable Storage Device

General Technical Data

Power Supply / Power Consumption

20 - 32 V DC / typ. 550 W
max. 800 W, depending on integrated optional components
Ø 524 mm x 743 mm (without flange mounted carrying handles)
approx. 70 kg without any camera but including a typical IMU/GNSS unit
approx. 75 kg with optional components

Main Dimensions (flange diameter x height)
Weight

Protection Class
Max. Flight Altitude operating / not operating
Temperature Range operation / storage

IP54
18500 ft (5600 m) above MSL¹⁾ / 18500 ft (5600 m) above MSL
-5°C up to +35°C / -10°C up to +50°C

Recommended IMU/GNSS System ^{2) 3)}

IMU Accuracy ⁴⁾
Roll, Pitch
Heading
IMU Sampling Rate
Position Accuracy (typ.)

0.0025°
0.005°
200 Hz
0.05 m - 0.1 m

Optional Components VQ-1460

Primary Camera

Sensor Resolution
Sensor Dimensions (diagonal)
Focal Length of Camera Lens
Field of View (FOV)
Data Storage

RGB
e.g. 150 MPixel CMOS
66.7 mm (medium format)
50 mm
approx. 54.6° x 42.3°
1x U.2 SSD, up to 15.36 TByte each

1) Mean Sea Level

2) The recommended IMU is listed neither in the European Export Control List (i.e. Annex 1 of Regulation (EU) No. 2021/821 nor in the Canadian Export Control List. Detailed information on certain cases will be provided on request.

3) The RIEGL VQ-1460 Laser Scanning system supports different IMU/GNSS Systems, details on request.
4) One sigma values, no GNSS outages, post-processed with base station data



RIEGL Laser Measurement Systems GmbH, Headquarters
RIEGL USA Inc., Headquarters North America

RIEGL Japan Ltd.
RIEGL China Ltd.
RIEGL Australia Pty Ltd.
RIEGL Canada Inc.

RIEGL UK Ltd.
RIEGL South America Spa
RIEGL Deutschland Vertriebsgesellschaft mbH

Contact us

